

## Pressure transducers DMU 13 Vario

Part no. 31206

Pressure transducers DMU 13 Vario with local display

### benefits

- robust stainless steel housing
- high-precision measurements with integrated transducer
- mechanical, power-independent local display
- Zero calibration via magnet



### Application

For pressure measurements with a power-independent local display in combination with an electrical output signal.

### Description

The DMU 13 Vario pressure transducers consist of a mechanical Bourdon tube measuring element and a piezo-resistive polysilicon thin-film measuring cell. The Bourdon tube measuring element is used to provide an easy-to-read analogue local display. The display is power-independent. Due to the integrated pressure transducer, high-precision measurement in parallel is possible. A standardised current output is available for signal transmission and recording of measured data. The robust stainless steel housing has a solid baffle wall and blow out. The zero point of the electronic sensor can be corrected from the outside via a permanent magnet after voltage has been applied and within a given time window.

### Technical Specifications

#### Nominal size

100

#### accuracy class (EN 837-1/6)

1.0

#### Measuring accuracy

Deviation from the characteristic curve according to IEC 60770 – limit point calibration (non-linearity, hysteresis, repeatability)  
 $\leq \pm 0.3 \% \text{ FSO}$

#### Measuring range

0/10 bar

#### application area

static load: Full scale value

dynamic load: 0.9 x full scale value

short-term load: 1.3 x full scale value

#### Operating temperature range

Medium: -10/+85 °C

Ambient: -10/+60 °C

Storage: -10/+70 °C

#### Temperature error band

$\leq 0.15 \% \text{ FSO}/10 \text{ K}$  In compensated range -10/+80 °C

#### Housing

with solid baffle wall and blow-out

**window**

Laminated safety glass

**Process connection**

G1½B, bottom EN 837-1/7.3

**material**

Housing: Stainless steel 304  
 pressure connection: stainless steel 316 Ti/316 L  
 diaphragm: Stainless steel 630/304

**wetted parts**

stainless steel 316 Ti/316 L, Stainless steel 630/304

**Supply voltage**

DC 10 – 32 V

**Output signal**

2-wire, 4–20 mA

**Load**

$$R_{max} = [(UB - UB_{min})/0.02 A] \Omega$$

**Current input**

< 25 mA

**Electrical connection**

Junction box

**Degree of protection**

IP 54 (EN 60529)

**Options**

- Housing filling (paraffin oil)
- Electrical contacts
- other process connections
- Fitting of chemical seal
- Range for positive and negative overpressure, e.g. -1/+3 bar

**Technical Drawings**

**DMU 13 Vario - bottom connection, with electrical contact**

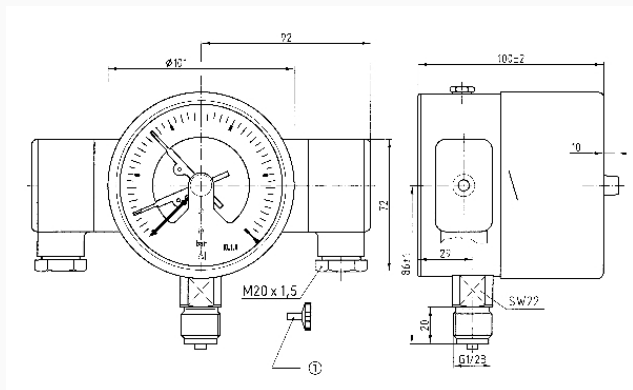

**Dimensions (mm)**

removable key, delivered loose with system

**Versions**

Range	Measuring range	Type	Version	Part no.
	0/10 bar	DMU 13 Vario	●	31206

- in-stock items
- Non-stock items