



Pressure transducers DMU 02 Vario programmable

Part no. 32843

Pressure transducers

benefits

- connection technology with numerous versions
- extremely resistant to shock, pulsation and vibration
- best dynamic pressure resistance at high load changes
- measuring cell welded without seals
- without transmission medium
- Turn Down 1:4
- Zero calibration via magnet

Application

For electronic pressure measurement in mechanical and plant engineering, and for gas and medical applications. Particularly suitable for pure media.

Description

Pressure transducers convert physical pressure into an electrical signal proportional to the pressure. DMU 02 Vario is equipped with a piezo-resistive polysilicon thin-film measuring cell. All standard electrical connection types are available. The measuring ranges can be changed via optional parameterisation hardware and software. The zero point can be corrected from the outside via a permanent magnet after voltage has been supplied and within a given time window.

Technical Specifications

Measuring accuracy

Deviation from the characteristic curve according to IEC 60770 – limit point calibration (non-linearity, hysteresis, repeatability)
 $\leq \pm 0.3 \% \text{ FSO}$

Measuring range

0/1.6 bar

Overpressure safety

$\leq 250 \text{ bar}$
 at least 2 x FS

Burst pressure

$\leq 250 \text{ bar}$
 at least 3 x FS

Operating temperature range

Medium: $-40/+125 \text{ }^\circ\text{C}$
 Ambient: $-40/+105 \text{ }^\circ\text{C}$
 Storage: $-40/+125 \text{ }^\circ\text{C}$

Temperature error band

$\leq \pm 0.15 \% \text{ FSO}/10 \text{ K}$ In compensated range $-10/+80 \text{ }^\circ\text{C}$

dynamic characteristics

Response time: $< 4 \text{ ms}$

Process connection

G½B EN 837-1/7.3

material

Housing: Stainless steel 304

pressure connection: stainless steel 630/316 Ti/316 L

electr. measuring cell: Stainless steel 630/304

Supply voltage

DC 10 – 32 V

Output signal

2-wire, 4–20 mA

Load $R_{\max} = [(UB - UB_{\min})/0.02 \text{ A}] \Omega$ **Current input**

< 25 mA

electrical protection

short circuit proof and protected against reverse polarity

Electrical connection

Connector and junction box as per ISO 4400 (DIN 43650-A)

Degree of protection

IP 65 (EN 60529)

CE conformity

EMC Directive 2014/30/EU

RoHS Directive 2011/65/EU

Pressure Equipment Directive 2014/68/EU

Options

- other process connections
- other electrical connections
- Field housing (stainless steel)
- cleaned for oxygen
- other output signals
- Fitting of chemical seal
- customer-specific setting (damping, unit)
- programmable hardware and software
- other operating temperature ranges

Technical Drawings

DMU 02 Vario - connection G1/2B EN 837

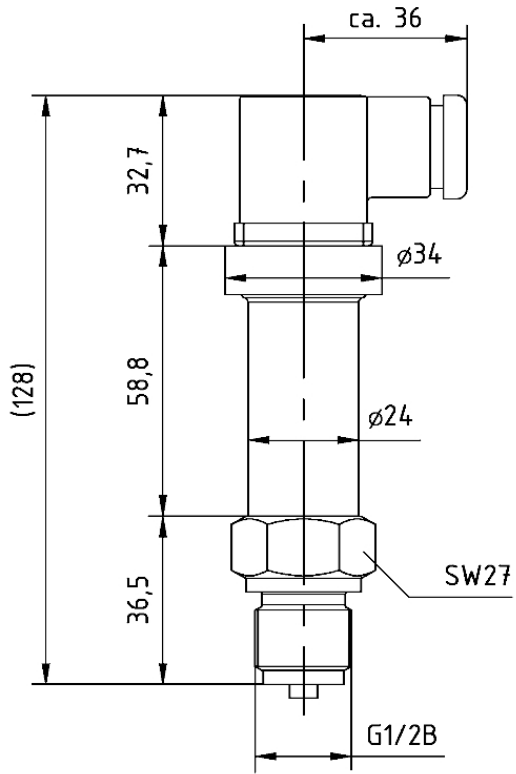

Dimensions (mm)

Versions

Range	Measuring range	Type	Version	Part no.
	0/1.6 bar	DMU 02 Vario	programmable	32843

- in-stock items
- Non-stock items