

Precision Bourdon tube pressure gauges RF160ChF

Part no. 85710412

Precision Bourdon tube pressure gauges

Technical Specifications

Type

D4

Nominal size

160

accuracy class (EN 837-1/6)

0.6

ranges

see ordering table

application area

static load: $\frac{3}{4}$ x full scale value
dynamic load: $\frac{2}{3}$ x full scale value
short-term: Full scale value

Operating temperature range

Ambient: -20/+60 °C

Degree of protection

IP 54 (EN 60529)

Connection

stainless steel 316 Ti/316 L, bottom back

Measuring element

Bourdon tube

≤ 60 bar: "C" type tube, stainless steel 316 Ti/316 L

> 60 bar: helical tube, stainless steel 316 Ti/316 L

movement

Brass/nickel silver, jewel bearing

Dial

Aluminium, white

Scaling: black

NG 160

Pointer

knife edge pointer

Aluminium, black

Housing

Stainless steel 304

bayonet bezel

Stainless steel 304

window

Plastic (PMMA)

Technical Drawings

NG 160 – bottom back connection

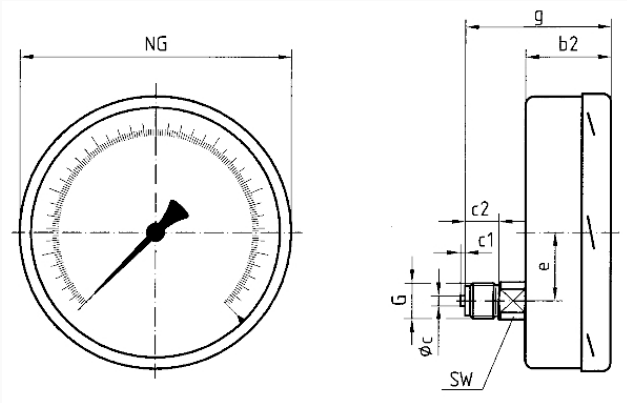

Dimensions (mm)

NG	b2	∅c	c1	c2	e	G	g	SW
160	50	6	3	20	44,5	G½B	82	22

Versions

Range	Mounting type	Type	Part number
0/1 bar	direct	RF160ChF D412	85710412

- in-stock items
- Non-stock items