



## Bourdon tube pressure gauges for chemical applications RF50Ch

Part no. 85069952

Bourdon tube pressure gauges for chemical applications Type D9

### benefits

- for chemical and process engineering applications
- measuring system fully welded to housing
- extremely robust design
- for temperatures of the medium of up to 200 °C
- tightness-tested with helium
- GOSSTANDART-certified
- Ex version (optional)

### Application

For corrosive gaseous and liquid media which are not highly viscous and do not crystallise; suitable for corrosive environments.  
! For measuring gas or vapour, observe the table "Selection Criteria as per EN 837-2"!

### Technical Specifications

**Type**  
D9

**Nominal size**  
50

**accuracy class**  
EN 837-1/6  
NG 50  
1.6

**ranges (EN 837-1/5)**  
see ordering table

**application area**  
static load:  $\frac{3}{4}$  x full scale value  
dynamic load:  $\frac{2}{3}$  x full scale value  
short-term: Full scale value

### Operating temperature range

NG 50  
max. 150 °C  
Ambient: -20/+60 °C

### Temperature performance

Indication error when the temperature of the measuring system deviates from the normal temperature of 20 °C:  
at rising temperature approx.  $\pm 0.4$  %/10 K  
falling temperature approx.  $\pm 0.4$  %/10 K  
of full scale value

### Degree of protection

IP 65 (EN 60529)

### Connection

Stainless steel 316 L, bottom back

**Measuring element**

Bourdon tube, stainless steel 316 Ti/316 L  
 ≤ 60 bar: "C" type tube  
 > 60 bar: helical tube  
 tightness-tested with helium

**movement**

Stainless steel

**Dial**

Aluminium, white  
 Scaling: black

**Pointer**

Aluminium, black

**Housing**

Stainless steel 304, with blow-out

**bayonet bezel**

NG 50  
 Stainless steel 304

**crimped bezel**

NG 50

**window**

NG 50  
 Plastic

**Options**

- Brass movement
- Back flange (NG 63)
- clamp fixing
- Ex version
- Crimped bezel, polished
- special scales
- other process connections

**Technical Drawings**

**NG 50 – bottom back connection, with clamp fixing**

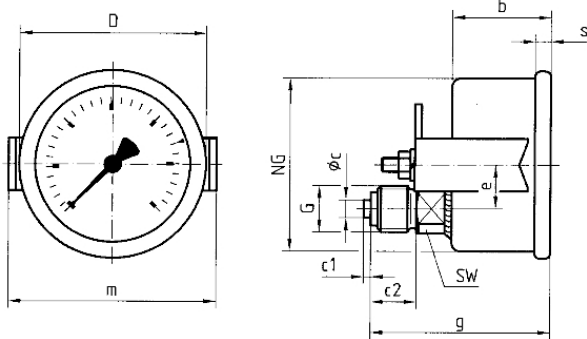

**Dimensions (mm)**

NG	b	∅c	c1	c2	D	e	G	g	m	s	SW
50	28	5	2	13	53	12,5	G¼B	51	59	4,5	14

## Versions

Range	Mounting type	Type		Part number
0/60 bar	clamp fixing	RF50Ch D952	●	85069952

- in-stock items
- Non-stock items