



## Bourdon tube pressure gauges for chemical applications RF63Ch

Part no. 85118912

Bourdon tube pressure gauges for chemical applications Type D9

### benefits

- for chemical and process engineering applications
- measuring system fully welded to housing
- extremely robust design
- for temperatures of the medium of up to 200 °C
- tightness-tested with helium
- GOSSTANDART-certified
- Ex version (optional)

### Application

For corrosive gaseous and liquid media which are not highly viscous and do not crystallise; suitable for corrosive environments.  
! For measuring gas or vapour, observe the table "Selection Criteria as per EN 837-2"!

### Technical Specifications

#### Type

D9

#### Nominal size

63

#### accuracy class

EN 837-1/6

NG 63

1.6

#### ranges (EN 837-1/5)

see ordering table

#### application area

static load:  $\frac{3}{4}$  x full scale value

dynamic load:  $\frac{2}{3}$  x full scale value

short-term: Full scale value

#### Operating temperature range

NG 63

max. 200 °C

Ambient: -20/+60 °C

#### Temperature performance

Indication error when the temperature of the measuring system deviates from the normal temperature of 20 °C:  
at rising temperature approx.  $\pm 0.4$  %/10 K  
falling temperature approx.  $\pm 0.4$  %/10 K  
of full scale value

#### Degree of protection

IP 65 (EN 60529)

#### Connection

Stainless steel 316 L, centre back

#### Measuring element

Bourdon tube, stainless steel 316 Ti/316 L  
 $\leq 60$  bar: "C" type tube  
 $> 60$  bar: helical tube  
tightness-tested with helium

#### movement

Stainless steel

#### Dial

Aluminium, white

Scaling: black

**Pointer**

Aluminium, black

**Housing**

Stainless steel 304, with blow-out

**bayonet bezel**

NG 63

**crimped bezel**

NG 63

Stainless steel 304

**window**

NG 63

Laminated safety glass

**Options**

- Brass movement
- Back flange (NG 63)
- clamp fixing
- Ex version
- Crimped bezel, polished
- special scales
- other process connections

**Technical Drawings**

**NG 63 – centre back connection**

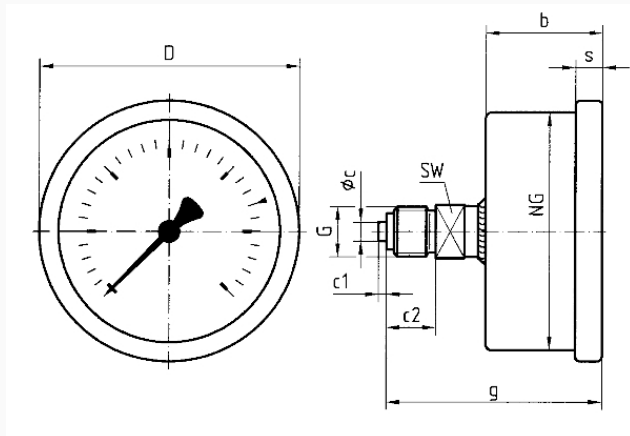

**Dimensions (mm)**

NG	b	∅c	c1	c2	D	G	g	s	SW
63	32	5	2	13	68	G¼B	56	7	14

**Versions**

Range	Mounting type	Type	Part number
0/40 bar	direct	RF63Ch D912	85118912

- in-stock items
- Non-stock items