



Standard capsule pressure gauges KP160

Part no. 35159451

Standard capsule pressure gauges Type D4

benefits

- with zero correction
- optional overpressure and/or underpressure safety 10 x FSD
- extremely low measuring ranges from 0/6 mbar
- GOSSTANDART-certified

Application

For gaseous, dry media which do not attack copper alloys.

! For measuring gas or vapour, observe the table "Selection Criteria as per EN 837-2" (see appendix)!

Technical Specifications

Type

D4

Nominal size

160

accuracy class (EN 837-3/6)

1.6

ranges (EN 837-3/5)

see ordering table

application area

static load: Full scale value
dynamic load: 0.9 x full scale value
overload safety: 1.3 x full scale value

Operating temperature range

Medium: max. 60 °C
Ambient: -20/+60 °C

Temperature performance

Indication error when the temperature of the measuring system deviates from the normal temperature of 20 °C:
at rising temperature approx. $\pm 0.6 \%$ /10 K
falling temperature approx. $\pm 0.6 \%$ /10 K
of full scale value

Degree of protection

NG 160
IP 33 (EN 60529)

Connection

Brass, centre back

Measuring element

Capsule element, CuBe alloy

movement

Brass

Zero correction

from the front

Seal
NBR (Perbunan)

Dial
Aluminium, white
Scaling: black

Pointer
Aluminium, black

Housing
Stainless steel 304

bayonet bezel
Stainless steel 304

window
D451
Plastic (PMMA)

Options

- overpressure and underpressure safety 10 x FSD
- back flange
- Panel mounting bezel, with window, plastic
- 3-hole fixing, panel mounting bezel with window, plastic
- throttle screw
- Reference pointer
- special scales
- other process connections

Technical Drawings

Centre back connection, panel mounting bezel with clamp fixing

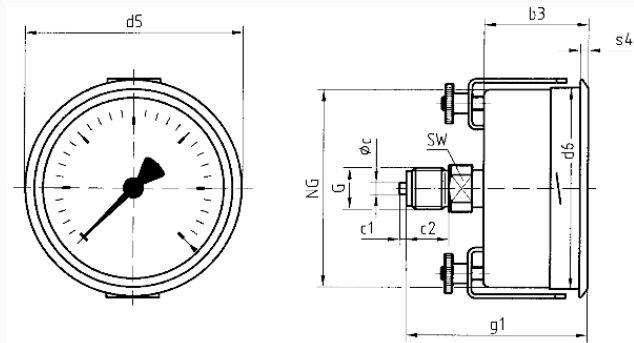

Dimensions (mm)

NG	b3	∅c	c1	c2	d5	d6	G	g1	s4	SW
63	37	5	2	13	68	64	G¼B	60	3	14
100	49	6	3	20	107	101	G½B	81	4	22
160	52	6	3	20	167	161	G½B	84	4,5	22

Versions

Range	Mounting type	Type	Part number
-250/+0 mbar	Panel mounting bezel, with clamp fixing	KP160 D451	35159451

- in-stock items
- Non-stock items